

ARC-8050T5U Desktop Series

Thunderbolt™ 5 and USB 3.2 Gen2



Step 1: Unpack the ARC-8050T5U Unit

Checklist

- 1 x ARC-8050T5U-4/6/8/12-bays RAID storage unit
- 1 x 1m 80Gbps TBT5 Type-C cable
- 1 x Power cord
- 16/24/32/48 x Drive mounting screws (4 per drive tray)

Step 2: Install NVMe x1(U.2/U.3)/SAS/SATA or SAS/SATA-only Drives

Secure the drive to the tray by four of the mounting screws and slide all drives into the enclosure.

Step 3: Connect Thunderbolt 5 Ports on RAID Storage

Thunderbolt connectors are provided on the back of the ARC-8050T5U RAID storage for connecting the array to Thunderbolt host or USB host.

Thunderbolt Computer Port Connection

Connect the cable to the upstream interface port on the back of your ARC-8050T5U RAID storage and to your Thunderbolt capable computer using the included Thunderbolt 5 cable as shown below:

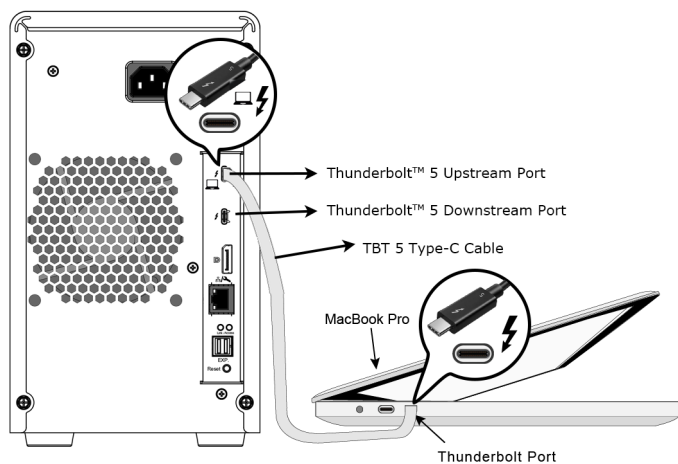

NOTE:

A single Thunderbolt technology daisy chain can have seven devices, including the computer. Connect the cable to one of the interface ports on the back of your ARC-8050T5U RAID storage and to your Thunderbolt capable computer. The additional port may be used to daisy chain compatible computer peripherals, such as hard drives, monitors, and much more.

USB-only Computer Port Connection

Your USB-only computer can recognize up to 4 volume when connecting any Thunderbolt 5 port on the ARC-8050T5U. The additional port can't support the daisy chain function.

- Computer with a USB-C port

Connect the cable to upstream port on the back of ARC-8050T5U RAID storage and USB-only computer USB-C port using the USB-C cable as shown below:

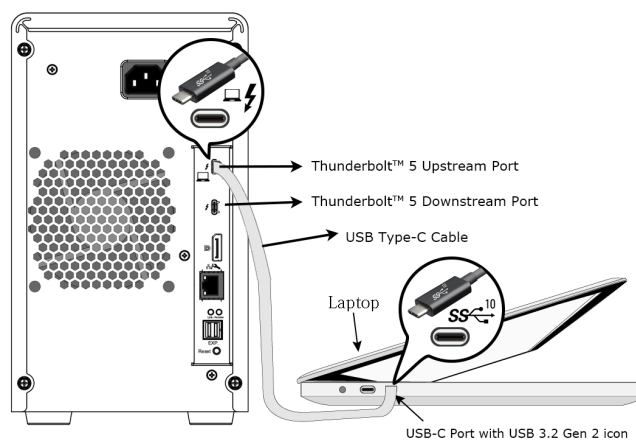

Step 4: Expansion Port Connection (Optional)

The ARC-8050T5U-6/12 -bay RAID storages contain one SFF-8644 expansion port that can connect up to 7 expander enclosures. The maximum drive no. is 256 through this RAID storage with 7 expander enclosures.

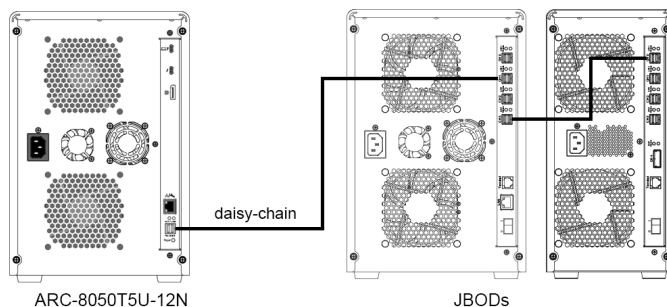

Step 5: Connect Power Cord

1. Connect power cord to a grounded electrical outlet and to the ARC-8050T5U RAID storage.
2. ARC-8050T5U RAID storage will automatically turn on when host computer power on status is received from the thunderbolt cable. It takes about 30 seconds to fully start up the RAID storage.
3. ARC-8050T5U RAID storage automatically turns off when the computer to which it is attached sleeps or is disconnected.

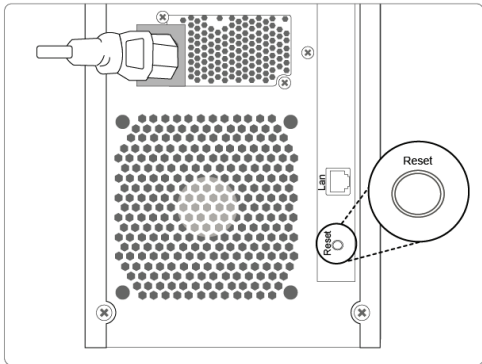

Step 6: Install the Thunderbolt Software & Driver Package

- 1-1. Download the Dext/Kext driver and install-mraid utility from the website at <https://www.areca.com.tw/support/downloads.html> (Mac)
- 1-2. Download the install_thunderbolt_x64 installer from the website at : <https://www.areca.com.tw/support/downloads.html> (PC)
2. Navigate to your downloads folder and double-click the driver/utility (Mac) or installer utility (PC) software
3. Follow the installer on-screen steps to complete installation.

Step 7: Launch Manager

※ Method 1: Web Storage Manager from LAN Port

User can remote manage the ARC-8050T5U series without adding any user specific software (platform independent) via standard web browsers directly connected to the Gigabit Ethernet RJ45 LAN port. Connect LAN port of the ARC-8050T5U using the included Ethernet cable and then to a LAN port or LAN switch. The IP address default shows in the LCD screen. Launch the Web Browser-based RAID manager by entering [http://\[IP Address\]](http://[IP Address]) in the web browser.

※ Method 2: Web Storage Manager through ArchHTTP (in MRAID)

1. [Mac users] There is one "MRAID" folder showing on your desktop. Double-click on the "MRAID" folder icon to locate your ArchHTTP utility and CLI program file folder. Double-click on the "ArchHTTP64" to launch manager.

[Windows users] There is " ArchHTTP icon showing on your system tray. Double-click on the icon to launch manager.
2. When you double-click on the "ArchHTTP64", it automatically scans the localhost RAID storage or adapters on the system and creates an total Controller List icon located in the left column screen. The child element belonged each RAID storage or adapters appear on the right column screen

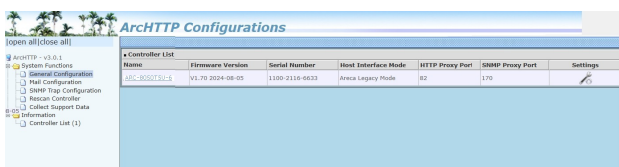

3. Locate "ARC-8050T5U Web Management" and launch the selected storage manager.

Step 8: Login

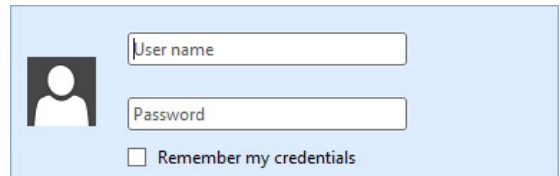

Type the User Name and Password. The RAID controller default User Name is "admin" and the Password is "0000". After entering the user name and password, click the button to access the storage manager.

See the chapter 4 of Web Browser-based Configuration on the user manual detailing the Web Storage Manager to customize your RAID configuration.

If you need more detail information, please download ARC-8050T5U manual from the website below:

- <https://www.areca.com.tw/products/thunderbolt-8050T5U.html>
- <https://www.areca.com.tw/support/downloads.html>

Step 9: Quick Create RAID Set and Volume

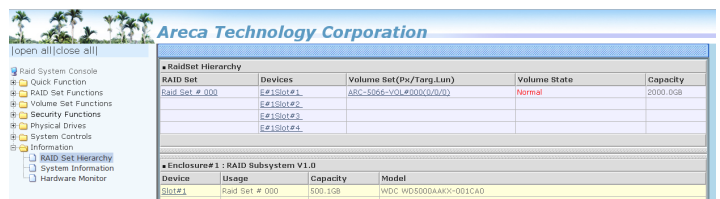

Click on the "Quick Create" in the main menu, your volume is automatically configured based on the number of disks in your system. You can create a RAID set associated with exactly one volume set. The user can change the Raid Level, Capacity, Initialization Mode, and Stripe Size. A hot spare option is also created, depending on the exist configuration. Tick on the "Confirm The Operation" check box and click on the "Submit" button, the RAID set and volume set will start to initialize. If you prefer to customize your volume set, please use the "Raid Set Functions" and "Volume Set Functions". See chapter 4 of ARC-8050T5U user manual for information on customizing your RAID volumes using the storage manager. Otherwise, to begin using the ARC-8050T5U right away.

* Using LCD Panel to Manage and Monitor

You can use LCD front panel and keypad function to simply create the RAID volume. The LCD status panel also informs you of the disk array's current operating status at a glance. The LCD provides a system of screens with areas for information, status indication, or menus. The manufacture default password is set to 0000. The initial screen is as following:

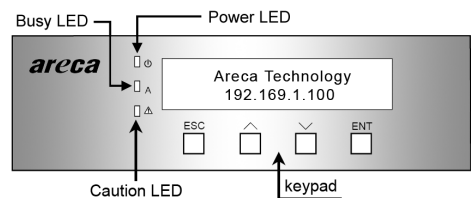

For additional information on using the LCD to configure the RAID subsystem see the LCD manual. You can download it from the website below:

http://www.areca.us/support/download/RaidCards/Documents/Manual_Spec/LCD_manual.zip



TEL:886-2-87974060 FAX: 886-2-87975970

Technical Support: support@areca.com.tw

Sales Information: sales@areca.com.tw

